

Harvey Cement Products, Inc.

Since 1947

16030 Park Avenue, Harvey, IL 60426

Ph: 708.333.1900 F: 708.333.1910

www.harveycement.com

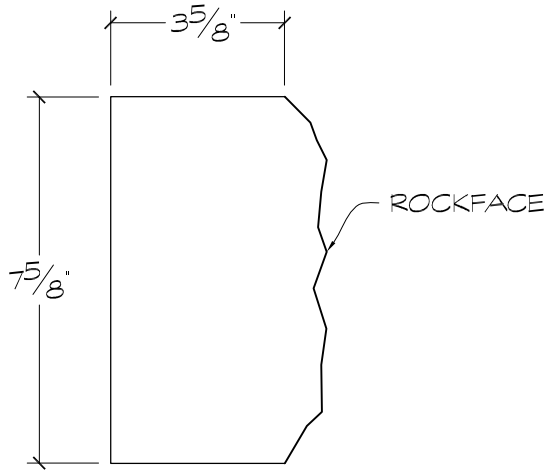

PROFILE

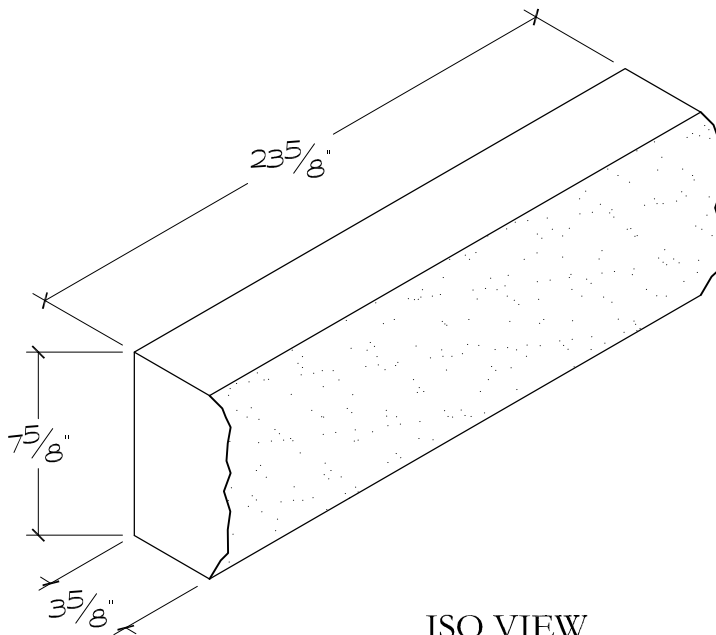

ISO VIEW

Profile ID

4824-RF

SUGGESTED USE

Sill	
Transition Band	
Coping	
Cap	
Field	X
Band	X
Cornice	

TYPE / SIZE
AVAILABILITY

TYPE	LENGTH(S)
Straight	23 5/8"

FINISH

Rockface

SavannaStone®